



**OPPEIN**

# FRAMELESS EURO STYLE CABINET

THE WORLD'S LARGEST CABINETRY MANUFACTURER



**OPPEIN**

## OPPEIN CABINETRY

Add: 474 Attwell Dr, Etobicoke, ON M9W 5C3  
[www.oppeincabinetry.ca](http://www.oppeincabinetry.ca)

☎ 1-416-798-8885      ✉ [Info@oppeincabinetry.ca](mailto:Info@oppeincabinetry.ca)

## OPPEIN HOME GROUP INC.

Add: #366, Guanghua 3rd Road, Baiyun District, Guangzhou, China  
[www.oppeinhome.com](http://www.oppeinhome.com)



360° Kitchen Showroom



360° Bathroom Showroom



360° Door Showroom

**OPPEIN**

*THERE IS HOME, THERE IS LOVE, THERE IS OPPEIN*



## CONTENTS

---

01	COMPANY PROFILE
09	SLAB SERIES
10	HIGH GLOSS SERIES
11	SHAKER SERIES
15	CABINET SPECIFICATIONS





Guangzhou Headquarters

## ABOUT OPPEIN

Founded in 1994, OPPEIN is China's No.1 kitchen and customized home decor brand, and the world's largest cabinetry manufacturer. We design and manufacture high-quality kitchens, wardrobes, bespoke home furniture, bathroom products, interior doors, aluminum windows & doors and home furnishing, capable of offering one-stop home decor products and solutions. Output and sales of kitchen cabinet reached 830 thousand sets, ranking No.1 in the kitchen industry.

In 2021, OPPEIN's sales turnover reached USD 3.14 billion, harvesting its consecutive 28th years of growth. Output and sales of cabinets reached 6 million sets, ranking No.1 in the cabinetry industry. Our products have been exported to 118 countries and regions, and the total market value of OPPEIN exceeded 100 billion yuan (USD 15.3 billion) in March 2021.

In overseas markets, what sets us apart from our competitors is our Italy design, European quality, one-stop whole-house products & solutions, and reliable local services.

OPPEIN takes great pride in its extensive franchise distribution system. We have a productive showroom operation model and thoughtful support policies to help the franchisees win. Currently, we have a remarkable number of over 7,200 franchise showrooms worldwide to serve local retail businesses.

The global project business is another importance we attach to. We cooperate closely with builders, developers, contractors, and architects to develop different types of residential and commercial business; up to now, we have completed over 10,000 real estate projects around the globe, including some significant local landmark projects.

We achieve this through our unceasing striving for perfection, and the passion to satisfy an individual's needs for better home décor. Our vision is to make OPPEIN a modern, innovative company respected and loved by the people, held in the highest esteem in China, and emulated around the world.

Where there is home and love, there OPPEIN is.

## OPPEIN AI SYSTEMS

All-digital Intelligent Manufacturing Production System

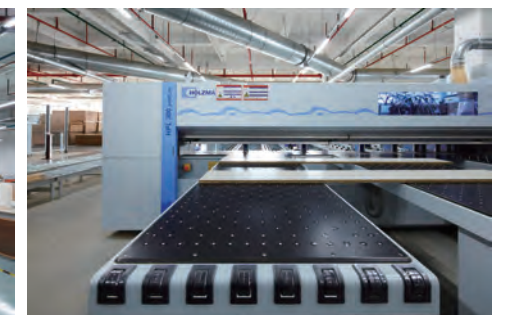



## QUALITY TESTS-FUNCTIONAL AND CONTINUOUS OPERATION

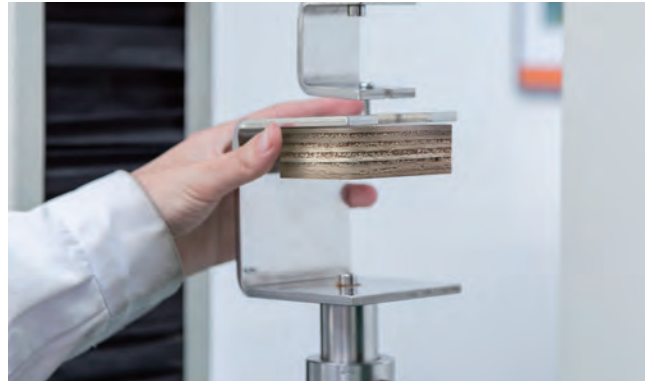

### SCREW & NAIL HOLDING PERFORMANCE TESTS

Nails and screws are the most commonly used fasteners used for wood and wood based products. To test the various loads and ways in which nails and screws fail, they are tested in tension using withdrawal and pull-through tests and in shear using lateral movement tests.



### COUNTERTOP BENDING STRENGTH TEST

Countertop bending tests are conducted by placing a length of material across a span and pushing down along the span to bend the material until failure. Bending tests reveal the elastic modulus of bending, flexural stress, and flexural strain of our countertops.



### THICKNESS SWELLING TEST

Samples are horizontally submerged under 1 inch of water, and after 2 hours, the samples are removed from water, drained, and weight and thickness are then measured. The samples are then submerged for an additional 22 hours and then measured.



### EDG BAND TEMPERATURE CYCLE TEST

Temperature Cycle Test (TCT) determines the ability of sealed edge bands to resist extremely low and extremely high temperatures, as well as their ability to withstand cyclical exposures to these temperature extremes.

### HINGE SALT TEST

Hinges are subjected to salt spray tests within the controlled environment to simulate an artificial atmosphere. Products are placed in the cabinet for a specific time period where a fine mist of salt water is allowed to 'attack' the products and identify the level of corrosion resistance that they can stand.

## QUALITY TESTS-FORMALDEHYDE EMISSION



### FORMALDEHYDE EMISSION TESTS -PERFORATOR METHODS

Perforator method is suitable for uncoated PB,MDF and OSB. It determines the formaldehyde content in mg/100g.The standard of European class E1 is less than 8.0mg/100g.

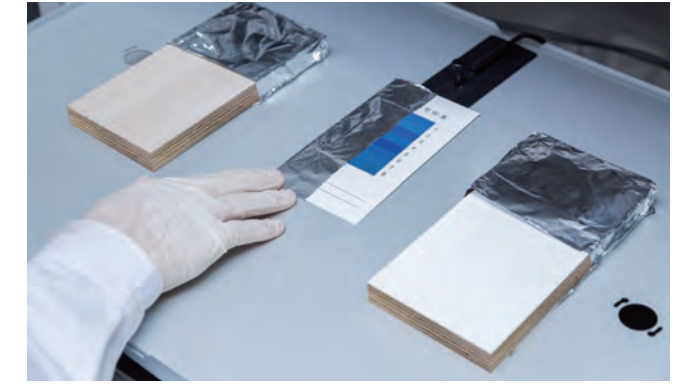

### COLOR FASTNESS FOR THERMOFOIL -FACED BOARDS

Color fastness test is made using filtered xenon arc lamps which simulate UV and visible solar radiation to assess the accelerated light ageing of thermofoil surface, which are sensitive to the long-wave and visible wavelengths of sunlight.



### FORMALDEHYDE EMISSION TESTS -DESICCATOR METHODS

Perforator method is suitable for uncoated or coated MDF and PB It determines the formaldehyde content in mg/L.The Japanese JIS standards F4 is less than 0.3mg/L.





## MILESTONE

**1994**

Oppein Home Group was established and produced the first integrated kitchen.

**2004**

Started the business of bathroom and sanitary ware.

**2006**

Started the business of wardrobe business.

**2010**

Started the business of interior door.

**★ 2015**

The Group launched a new high-end brand: Oppolia to further improve the customer service system and enhance brand value.

**2016**

Proceeded Whole House Customization Mall, leading the second revolution in the industry.

**2017**

Went public in Shanghai Stock Exchange with stock code 603833.

**2018**

Started the business of metal doors and windows.

**2019**

Won the awards of China's Top 500 Manufacturing Enterprises /Pioneer in the High-Quality Development of China's Listed Companies

**2021**

The total market value of OPPEIN 2021 exceeded USD 15.3 billion in March 2021. Get Reddot award 2021 winner.



## FRAMELESS EURO STYLE CABINET STRUCTURE

- ① Door Panel for diversified Choices
- ② 6 Ways & soft-close hinge for easy adjustment
- ③ 3/4" plywood shelf and side panel for best quality
- ④ Adjustable Legs 4 1/4"~5 1/4" for more adjustable space
- ⑤ 5mm back panel with top and bottom enforced rail for Classic Euro style
- ⑥ Metalbox Drawer System for minimalism style:
  - a. 1/2" metal side panel with OPPEIN logo on both sides.
  - b. 5/8" melamine laminated plywood for bottom and back panel.
  - c. concealed slide.
- ⑦ Aluminum & Door Material Toe-kick for different design
- ⑧ Screw with dowels for easy assembly & sturdy structure
- ⑨ Full-access & Soft-closing drawer for modern experience

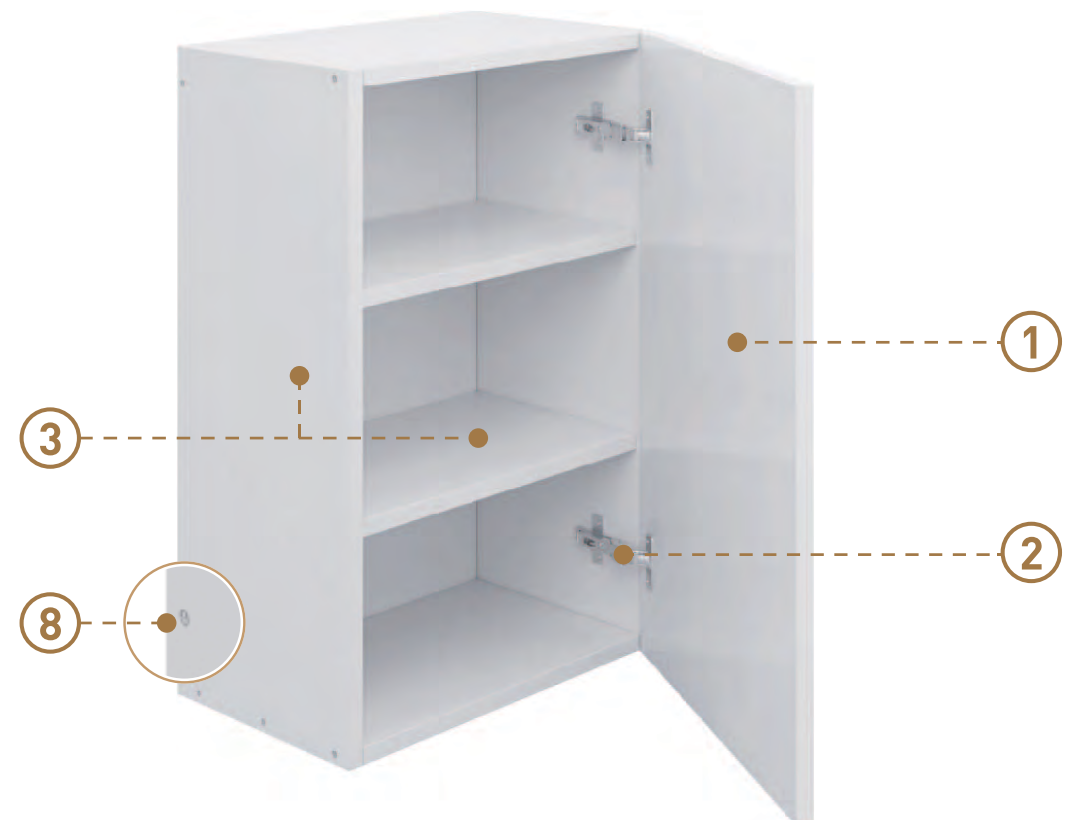
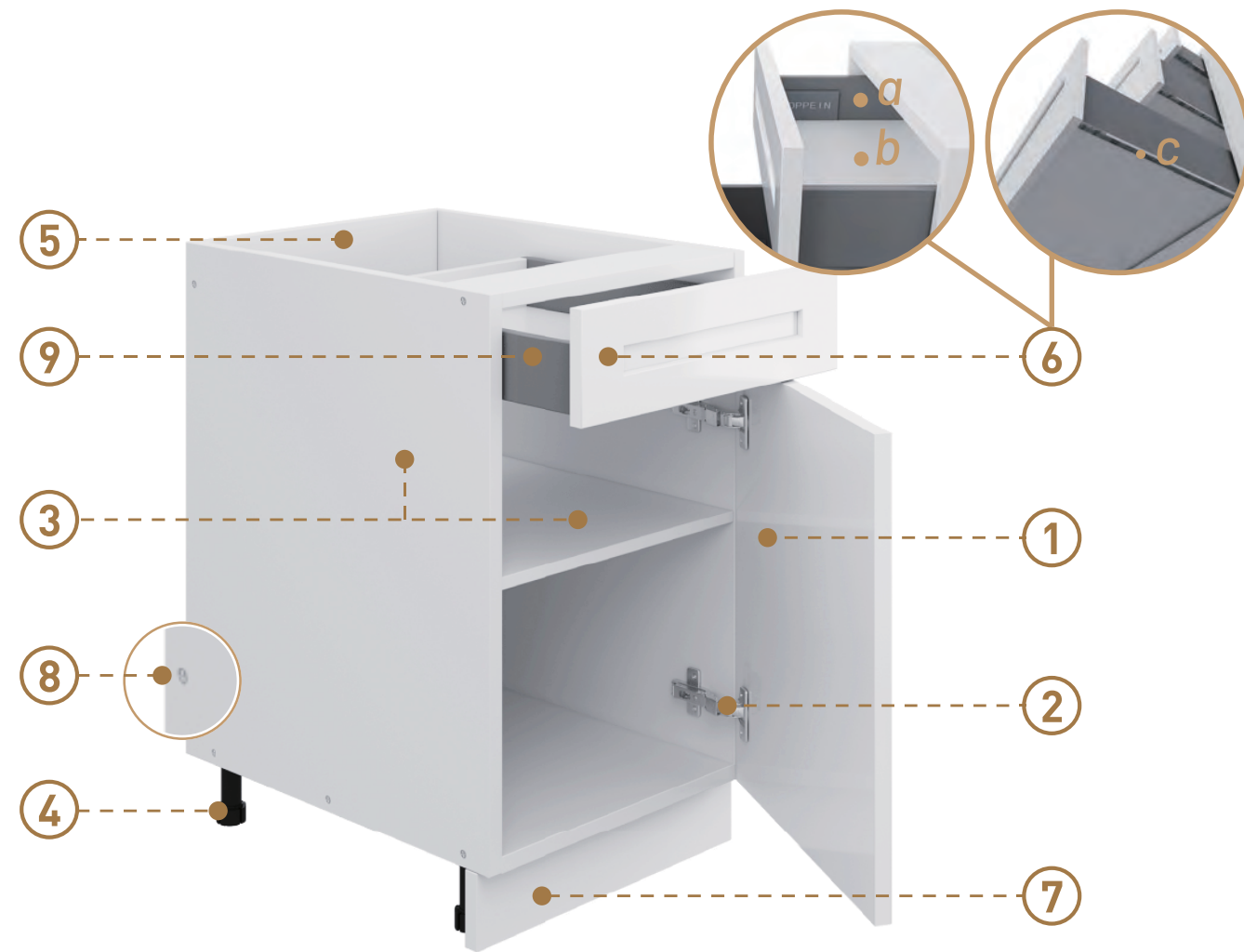





## SLAB SERIES

- 1-Superior screw holding capacity and load bearing capacity.
- 2-The HOMAG machine finishes all processes with excellent moisture and starch resistance.
- 3-A variety of choices while price is more acceptable.

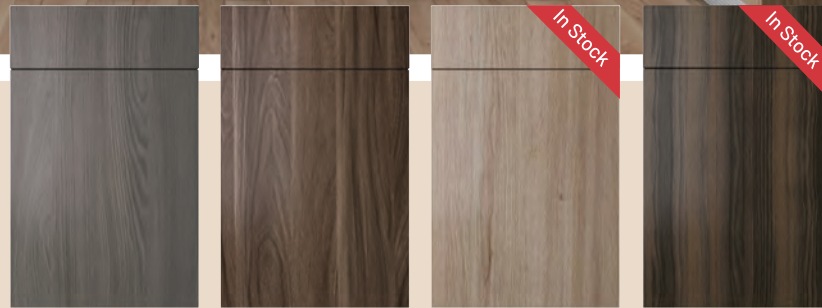

Ash Oak (MAO)    Autumn Walnut (MAW)    Natural Wood (MNW)    Smoked Oak (MSO)



## HIGH GLOSS SERIES

- 1-Despite the shiny and glass-like plexiglass coating, these products have a great effect on the beauty of modern and simple design.
- 2-Shows the space brighter due to having shiny surfaces and light reflection.
- 3-The smooth and shiny surface of these cabinets makes them easy to clean.



Glossy White (PGW)    Glossy Ash (PGA)    Glossy Gray (PGG)





## SHAKER SERIES

The narrow shaker detail gives it a touch of modern styling while maintaining a classic feel.



In Stock

Slim Shaker White  
(SSW)

- HDF material
- Greater resistance to impact and torsion
- Great stability, Lower expansion coefficient
- Bending Resistant





# SHAKER SERIES

The frame material is E1 HDF or solid wood, the core material with E1 HDF formaldehyde emission  $\leq 0.124 \text{ mg/m}^3$ , and the stiles and rails are connected by tenons.



White Single Shaker (WSS)



Gray Single Shaker (GSS)



Blue Single Shaker (BSS)





## Cabinet Specifications



12"/15"/18"/21"

### 1. Base Cabinet (1 Drawer + 1 Door)

SKU	Dimensions
B12	12"W x 30"H x 23 7/8"D
B15	15"W x 30"H x 23 7/8"D
B18	18"W x 30"H x 23 7/8"D
B21	21"W x 30"H x 23 7/8"D
BTC18	18"W x 30"H x 23 7/8"D

#### Includes:

- One (1) universal cabinet box.
- One (1) drawer with metalbox and soft close slide.
- One (1) door with HINGE105° (6 ways & soft close).
- One (1) adjustable shelf with shelf pegs.
- Four (4) adjustable Legs 4 1/4"~5 1/4"
- One (1) trash can for BTC18
- Screws, dowels and required hardware.

#### NOTE:

- Use BEP/MBEP panels to cover exterior sides if exposed.
- Need to install TK8/A-TK10/B-TK10 at the bottom of the cabinet.

### 2. Base Cabinet (1 Drawer + 2 Door)

SKU	Dimensions
B24	24"W x 30"H x 23 7/8"D
B27	27"W x 30"H x 23 7/8"D
B30	30"W x 30"H x 23 7/8"D
B33	33"W x 30"H x 23 7/8"D
B36	36"W x 30"H x 23 7/8"D

#### Includes:

- One (1) universal cabinet box.
- One (1) drawer with metalbox and soft close slide.
- Two (2) doors with HINGE105° (6 ways & soft close).
- One (1) adjustable shelf with shelf pegs.
- Four (4) adjustable Legs 4 1/4"~5 1/4"
- Screws, dowels and required hardware.

#### NOTE:

- Use BEP/MBEP panels to cover exterior sides if exposed.
- Need to install TK8/A-TK10/B-TK10 at the bottom of the cabinet.

## Cabinet Specifications

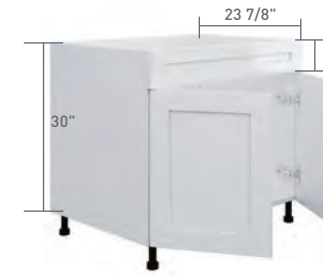

30"/33"/36"

### 3. Sink Base Cabinet (1 FK Drawer + 2 Door)

SKU	Dimensions
SB30	30"W x 30"H x 23 7/8"D
SB33	33"W x 30"H x 23 7/8"D
SB36	36"W x 30"H x 23 7/8"D

#### Includes:

- One (1) universal cabinet box.
- One (1) fake drawer panel.
- Two (2) doors with HINGE105° (6 ways & soft close).
- Four (4) adjustable Legs 4 1/4"~5 1/4"
- Screws, dowels and required hardware.

#### NOTE:

- Use BEP/MBEP panels to cover exterior sides if exposed.
- Need to install TK8/A-TK10/B-TK10 at the bottom of the cabinet.



42"/45"

### 4. Base Blind Corner Cabinet

SKU	Dimensions
BBC42	42"W x 30"H x 23 7/8"D
BBC45	45"W x 30"H x 23 7/8"D

#### Includes:

- One (1) universal cabinet box.
- One (1) door with HINGE105° (6 ways & soft close).
- One (1) adjustable shelf with shelf pegs.
- One (1) 6" filler for adjusting the spacing.
- Four (4) adjustable Legs 4 1/4"~5 1/4"
- Screws, dowels and required hardware.

#### NOTE:

- Use BEP/MBEP panels to cover exterior sides if exposed.
- Need to install TK8/A-TK10/B-TK10 at the bottom of the cabinet.

## Cabinet Specifications



### 5. Base Lazy Susan Cabinet

SKU	Dimensions
BER33	33"W x 30"H x 23 7/8"D
BER36	36"W x 30"H x 23 7/8"D
BLS33	33"W x 30"H x 23 7/8"D
BLS36	36"W x 30"H x 23 7/8"D

#### Includes:

- One (1) universal cabinet box.
- Two (2) folding doors with HINGE135° (regular) and HINGE155° (soft close) .
- One (1) adjustable shelf with shelf pegs.
- One (1) Lazy Susan for BLS cabinet
- Four (4) adjustable Legs 4 1/4"~5 1/4"
- Screws, dowels and required hardware.

#### NOTE:

- Use BEP/MBEP panels to cover exterior sides if exposed.
- Need to install TK8/A-TK10/B-TK10 at the bottom of the cabinet.

### 6. 3 Drawers Base Cabinet

SKU	Dimensions
3DB12	12"W x 30"H x 23 7/8"D
3DB15	15"W x 30"H x 23 7/8"D
3DB18	18"W x 30"H x 23 7/8"D
3DB21	21"W x 30"H x 23 7/8"D
3DB24	24"W x 30"H x 23 7/8"D
3DB27	27"W x 30"H x 23 7/8"D
3DB30	30"W x 30"H x 23 7/8"D
3DB33	33"W x 30"H x 23 7/8"D
3DB36	36"W x 30"H x 23 7/8"D

#### Includes:

- One (1) universal cabinet box.
- Three (3) drawers with metalbox and soft close slide.
- Four (4) adjustable Legs 4 1/4"~5 1/4"
- Screws, dowels and required hardware.

#### NOTE:

- Use BEP/MBEP panels to cover exterior sides if exposed.
- Need to install TK8/A-TK10/B-TK10 at the bottom of the cabinet.

## Cabinet Specifications

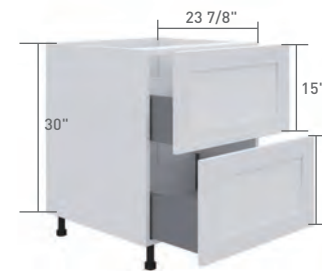

### 7. Base Cabinet 2 Drawer

SKU	Dimensions
2DB30	30"W x 30"H x 23 7/8"D
2DB36	36"W x 30"H x 23 7/8"D

#### Includes:

- One (1) universal cabinet box.
- Two (2) drawers with metalbox and soft close slide.
- Four (4) adjustable Legs 4 1/4"~5 1/4"
- Screws, dowels and required hardware.

#### NOTE:

- Use BEP/MBEP panels to cover exterior sides if exposed.
- Need to install TK8/A-TK10/B-TK10 at the bottom of the cabinet.

### 8. Base Cabinet

SKU	Dimensions
BSR09	9"W x 30"H x 23 7/8"D
BSR12	12"W x 30"H x 23 7/8"D
B06FH	6"W x 30"H x 23 7/8"D
B09FH	9"W x 30"H x 23 7/8"D

#### Includes:

- One (1) universal cabinet box.
- One (1) door and spice rack for BSR cabinet.
- One (1) door with HINGE105° (6 ways & soft close) for BFH cabinet.
- One (1) adjustable shelf with shelf pegs for BFH cabinet.
- Four (4) adjustable Legs 4 1/4"~5 1/4"
- Screws, dowels and required hardware.

#### NOTE:

- Use BEP/MBEP panels to cover exterior sides if exposed.
- Need to install TK8/A-TK10/B-TK10 at the bottom of the cabinet.

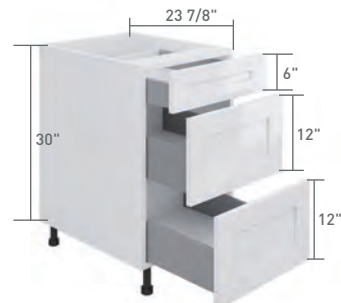



## Cabinet Specifications



### 9.Base Microwave Cabinet

SKU	Dimensions
BMC24	24"W x 30"H x 23 7/8"D
BMC30	30"W x 30"H x 23 7/8"D

#### Includes:

- One (1) universal cabinet box.
- One (1) drawer with metalbox and soft close slide.
- One (1) 2" filler at the top to adjust the spacing.
- Four (4) adjustable Legs 4 1/4"~5 1/4".
- Screws, dowels and required hardware.

#### NOTE:

- Use BEP/MBEP panels to cover exterior sides if exposed.
- Need to install TK8/A-TK10/B-TK10 at the bottom of the cabinet.

### 10-1.Wall Cabinet 1 Full Door

SKU	Dimensions
W0930	9"W x 30"H x 12"D
W1230	12"W x 30"H x 12"D
W1530	15"W x 30"H x 12"D
W1830	18"W x 30"H x 12"D
W2130	21"W x 30"H x 12"D
W0936	9"W x 36"H x 12"D
W1236	12"W x 36"H x 12"D
W1536	15"W x 36"H x 12"D

#### Includes:

- One (1) universal cabinet box.
- One (1) door with HINGE105° (6 ways & soft close).
- Two (2) adjustable shelves with shelf pegs for 30" & 36"H cabinet .
- Three (3) adjustable shelves with shelf pegs for 42"H cabinet .
- Screws, dowels and required hardware.

#### NOTE:

- Use WEP/MWEP panels to cover exterior sides if exposed.



## Cabinet Specifications



### 10-2.Wall Cabinet 1 Full Door

SKU	Dimensions
W1836	18"W x 36"H x 12"D
W2136	21"W x 36"H x 12"D
W0942	9"W x 42"H x 12"D
W1242	12"W x 42"H x 12"D
W1542	15"W x 42"H x 12"D
W1842	18"W x 42"H x 12"D
W2142	21"W x 42"H x 12"D

#### Includes:

- One (1) universal cabinet box.
- One (1) door with HINGE105° (6 ways & soft close).
- Two (2) adjustable shelves with shelf pegs for 30" & 36"H cabinet .
- Three (3) adjustable shelves with shelf pegs for 42"H cabinet .
- Screws, dowels and required hardware.

#### NOTE:

- Use WEP/MWEP panels to cover exterior sides if exposed.

### 11-1.Wall Cabinet 2 Door

SKU	Dimensions
W2430	24"W x 30"H x 12"D
W2730	27"W x 30"H x 12"D
W3030	30"W x 30"H x 12"D
W3330	33"W x 30"H x 12"D
W3630	36"W x 30"H x 12"D
W2436	24"W x 36"H x 12"D
W2736	27"W x 36"H x 12"D
W3036	30"W x 36"H x 12"D
W3336	33"W x 36"H x 12"D
W3636	36"W x 36"H x 12"D
W2442	24"W x 42"H x 12"D

#### Includes:

- One (1) universal cabinet box.
- Two (2) doors with HINGE105° (6 ways & soft close).
- Two (2) adjustable shelves with shelf pegs for 30" & 36"H cabinet .
- Three (3) adjustable shelves with shelf pegs for 42"H cabinet .
- Screws, dowels and required hardware.

#### NOTE:

- Use WEP/MWEP panels to cover exterior sides if exposed.



## Cabinet Specifications



### 11-2. Wall Cabinet 2 Door

SKU	Dimensions
W2742	27"W x 42"H x 12"D
W3042	30"W x 42"H x 12"D
W3342	33"W x 42"H x 12"D
W3642	36"W x 42"H x 12"D

#### Includes:

- One (1) universal cabinet box.
- Two (2) doors with HINGE105° (6 ways & soft close).
- Two (2) adjustable shelves with shelf pegs for 30" & 36"H cabinet .
- Three (3) adjustable shelves with shelf pegs for 42"H cabinet .
- Screws, dowels and required hardware.

#### NOTE:

- Use WEP/MWEP panels to cover exterior sides if exposed.

### 12-1. Wall Short Cabinet 1 Full Door

SKU	Dimensions
W1212	12"W x 12"H x 12"D
W1512	15"W x 12"H x 12"D
W1812	18"W x 12"H x 12"D
W2112	21"W x 12"H x 12"D

#### Includes:

- One (1) universal cabinet box.
- One (1) door with HINGE105° (6 ways & soft close).
- No Shelf.
- Screws, dowels and required hardware.

#### NOTE:

- Use WEP/MWEP panels to cover exterior sides if exposed.

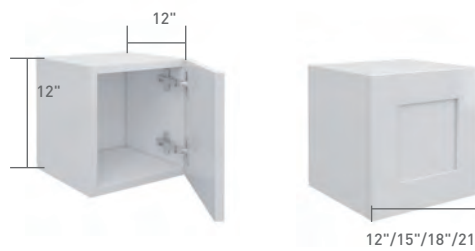

## Cabinet Specifications

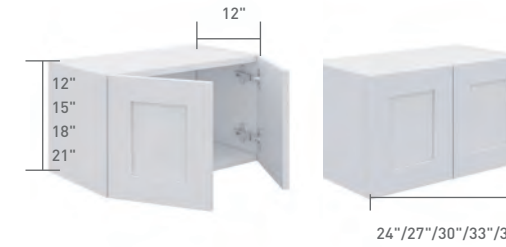

### 12-2. Wall Short Cabinet 2 Door

SKU	Dimensions
W2412	24"W x 12"H x 12"D
W2712	27"W x 12"H x 12"D
W3012	30"W x 12"H x 12"D
W3312	33"W x 12"H x 12"D
W3612	36"W x 12"H x 12"D
W3015	30"W x 15"H x 12"D
W3315	33"W x 15"H x 12"D
W3615	36"W x 15"H x 12"D
W3018	30"W x 18"H x 12"D
W3318	33"W x 18"H x 12"D
W3618	36"W x 18"H x 12"D
W3021	30"W x 21"H x 12"D
W3321	33"W x 21"H x 12"D
W3024	30"W x 24"H x 12"D
W3324	33"W x 24"H x 12"D
W3624	36"W x 24"H x 12"D

#### Includes:

- One (1) universal cabinet box.
- Two (2) doors with HINGE105° (6 ways & soft close).
- No shelf in 12" & 15" & 18" & 21" H.
- One (1) adjustable shelf with shelf pegs for 24"H cabinet .
- Screws, dowels and required hardware.

#### NOTE:

- Use WEP/MWEP panels to cover exterior sides if exposed.



## Cabinet Specifications

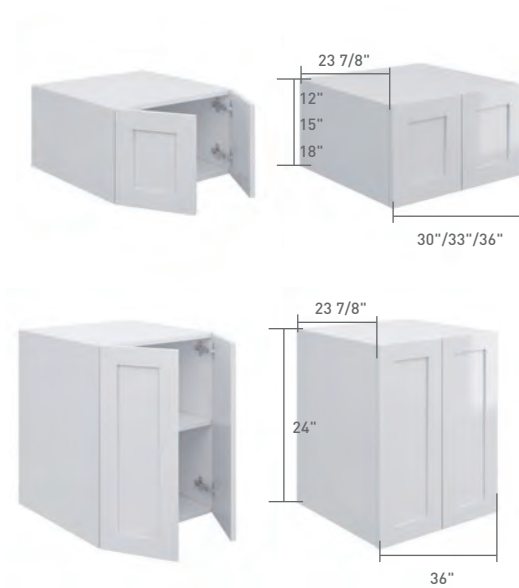

### 13. Wall Cabinet Fridge 2 Door

SKU	Dimensions
W301224	30"W x 12"H x 23 7/8"D
W331224	33"W x 12"H x 23 7/8"D
W361224	36"W x 12"H x 23 7/8"D
W301524	30"W x 15"H x 23 7/8"D
W331524	33"W x 15"H x 23 7/8"D
W361524	36"W x 15"H x 23 7/8"D
W331824	33"W x 18"H x 23 7/8"D
W361824	36"W x 18"H x 23 7/8"D
W362424	36"W x 24"H x 23 7/8"D

#### Includes:

- One (1) universal cabinet box.
- Two (2) doors with HINGE105° (6 ways & soft close).
- No shelf in 12" & 15" & 18"H.
- One (1) adjustable shelf with shelf pegs for 24"H cabinet.
- Screws, dowels and required hardware.

#### NOTE:

- Use WEP/MWEP panels to cover exterior sides if exposed.

### 14. Wall Easy Reach Cabinet

SKU	Dimensions
WER2412	24"W x 12"H x 12"D
WER2430	24"W x 30"H x 12"D
WER2436	24"W x 36"H x 12"D
WER2442	24"W x 42"H x 12"D

#### Includes:

- One (1) universal cabinet box.
- Two (2) folding doors with HINGE135° (regular) and HINGE155° (soft close).
- No shelf in 12"H.
- Two (2) adjustable shelves with shelf pegs for 30" & 36"H cabinet.
- Three (3) adjustable shelves with shelf pegs for 42"H cabinet.
- Screws, dowels and required hardware.

#### NOTE:

- Use WEP/MWEP panels to cover exterior sides if exposed.

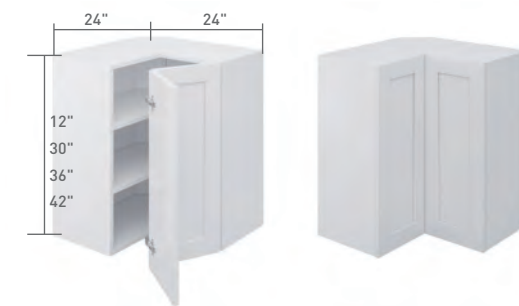

## Cabinet Specifications

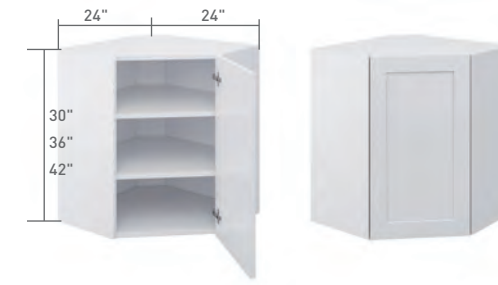

### 15. Wall Diagonal Cabinet

SKU	Dimensions
WDC2430	24"W x 30"H x 12"D
WDC2436	24"W x 36"H x 12"D
WDC2442	24"W x 42"H x 12"D

#### Includes:

- One (1) universal cabinet box.
- One (1) door with HINGE45° (soft close).
- Two (2) adjustable shelves with shelf pegs for 30" & 36"H cabinet.
- Three (3) adjustable shelves with shelf pegs for 42"H cabinet.
- Screws, dowels and required hardware.

#### NOTE:

- Use WEP/MWEP panels to cover exterior sides if exposed.

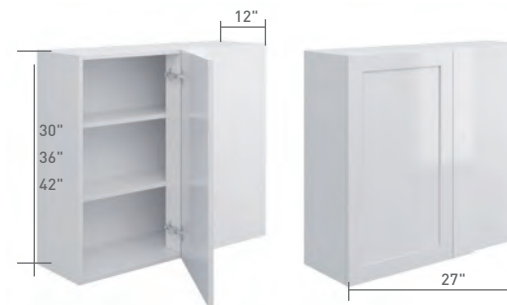

### 16. Wall Blind Corner

SKU	Dimensions
WBC2730	27"W x 30"H x 12"D
WBC2736	27"W x 36"H x 12"D
WBC2742	27"W x 42"H x 12"D

#### Includes:

- One (1) universal cabinet box.
- One (1) door with HINGE105° (6 ways & soft close).
- Two (2) adjustable shelves with shelf pegs for 30" & 36"H cabinet.
- Three (3) adjustable shelves with shelf pegs for 42"H cabinet.
- One (1) 6" filler for adjusting the spacing.
- Screws, dowels and required hardware.

#### NOTE:

- Use WEP/MWEP panels to cover exterior sides if exposed.



### 17. Wall Bi-Fold

SKU	Dimensions
WBF3030	30"W x 30"H x 12"D
WBF3630	36"W x 30"H x 12"D

#### Includes:

- One (1) universal cabinet box.
- Two (2) doors with BLUM fold lift and regular hinges.
- Two (2) adjustable shelves with shelf pegs
- Screws, dowels and required hardware.

#### NOTE:

- Use WEP/MWEP panels to cover exterior sides if exposed.
- 30"W require two hinges
- 36"W require three hinges

## Cabinet Specifications

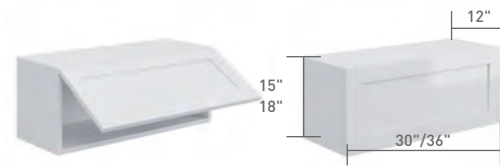

### 18. Wall Stay Lift

SKU	Dimensions
WSL3015	30"W x 15"H x 12"D
WSL3615	36"W x 15"H x 12"D
WSL3018	30"W x 18"H x 12"D
WSL3618	36"W x 18"H x 12"D

#### Includes:

- One (1) universal cabinet box.
- One (1) doors with BLUM stay lift HINGE105° (6 ways & soft close).
- No Shelf .
- Screws, dowels and required hardware.

#### NOTE:

- Use WEP/MWEP panels to cover exterior sides if exposed.
- 30"W require two hinges
- 36"W require three hinges

### 19. Pantry Cabinet 1 Side Door

SKU	Dimensions
PC1884	18"W x 84"H x 23 7/8"D
PC1890	18"W x 90"H x 23 7/8"D
PC1896	18"W x 96"H x 23 7/8"D

#### Includes:

- One (1) universal cabinet box.
- Two (2) doors with HINGE105° (6 ways & soft close).
- Three (3) adjustable shelves with shelf pegs and One (1) fixed shelf.
- Four (4) adjustable Legs 4 1/4"~5 1/4"
- Screws, dowels and required hardware.

#### NOTE:

- Height of cabinet include feet's height.
- Use REF/MTEP panels to cover exterior sides if exposed.
- Need to install TK8/A-TK10/B-TK10 at the bottom of the cabinet.

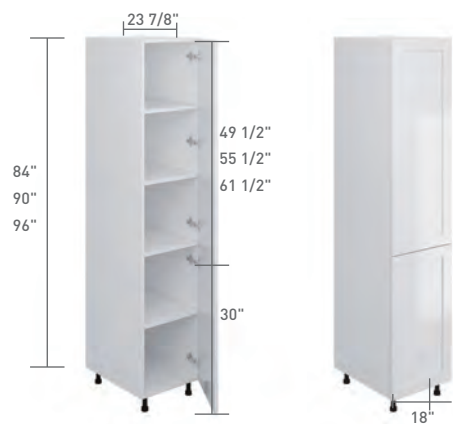

## Cabinet Specifications



### 20. Pantry Cabinet 2 Full Door

SKU	Dimensions
PC2484	24"W x 84"H x 23 7/8"D
PC3084	30"W x 84"H x 23 7/8"D
PC2490	24"W x 90"H x 23 7/8"D
PC3090	30"W x 90"H x 23 7/8"D
PC2496	24"W x 96"H x 23 7/8"D
PC3096	30"W x 96"H x 23 7/8"D

#### Includes:

- One (1) universal cabinet box.
- Four (4) doors with HINGE105° (6 ways & soft close).
- Three (3) adjustable shelves with shelf pegs and One (1) fixed shelf.
- Four (4) adjustable Legs 4 1/4"~5 1/4"
- Screws, dowels and required hardware.

#### NOTE:

- Height of cabinet include feet's height.
- Use REF/MTEP panels to cover exterior sides if exposed.
- Need to install TK8/A-TK10/B-TK10 at the bottom of the cabinet.

### 21. Double Oven Cabinet

SKU	Dimensions
DOC3084	30"W x 84"H x 23 7/8"D
DOC3090	30"W x 90"H x 23 7/8"D
DOC3096	30"W x 96"H x 23 7/8"D

#### Includes:

- One (1) universal cabinet box.
- Two (2) doors with HINGE105° (6 ways & soft close).
- One (1) drawer with metalbox and soft close slide.
- One (1) 2 1/2" filler at the top and bottom of cut-out space.
- One (1) adjustable shelf with shelf pegs on the top for 96" cabinet.
- Four (4) adjustable Legs 4 1/4"~5 1/4"
- Screws, dowels and required hardware.

#### NOTE:

- Height of cabinet include feet's height.
- Appliance cut-out height is 55 1/8"
- Use REF/MTEP panels to cover exterior sides if exposed.
- Need to install TK8/A-TK10/B-TK10 at the bottom of the cabinet.

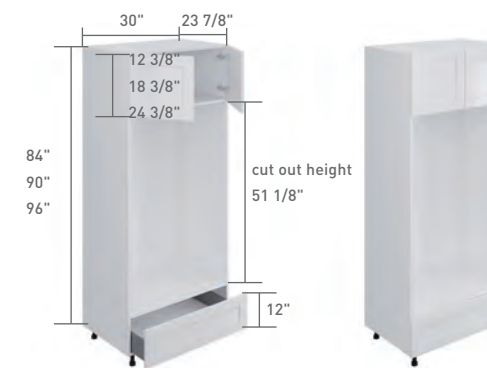



## Cabinet Specifications



### 22. Sample Door

SKU	Dimensions
sample11*15	11"W x 15"H

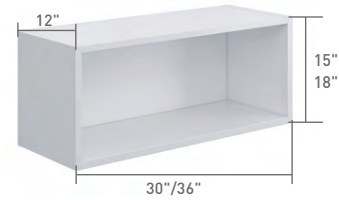

### 23. Open Shelf

SKU	Dimensions
WOC3015	30"W x 15"H x 12"D
WOC3615	36"W x 15"H x 12"D
WOC3018	30"W x 18"H x 12"D
WOC3618	36"W x 18"H x 12"D

**Includes:**

- One (1) cabinet box made of door material.
- No shelf.
- Screws, dowels and required hardware.

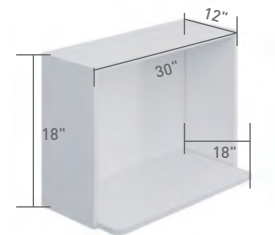

### 24. Wall Microwave Cabinet

SKU	Dimensions
WMC3018	30"W x 18"H x 12"D

**Includes:**

- One (1) cabinet box made of door material.
- Screws, dowels and required hardware.

**NOTE:**

- The bottom panel extends out for 6" to hold the microwave.



### 25. Dishwasher End Panel

SKU	Dimensions
DWEP3	3"W x 34 1/2"H x 24 3/4"D

**Includes:**

- One (1) return panel 34 1/2"H x 24"D
- One (1) filler 3"W x 34 1/2"H x 3/4"D
- Screws, dowels and required hardware.

**NOTE:**

- The filler cover return panel.

## Cabinet Specifications



### 26. Panel & Toe Kick

SKU	Dimensions
BEP24	24 3/4"W x 34 1/2"H
BEP26	25 1/4"W x 34 1/2"H
BEP36	37 1/4"W x 34 1/2"H
BEP48	49 1/4"W x 34 1/2"H
WEP1230	12 3/4"W x 30"H
WEP1236	12 3/4"W x 36"H
WEP1242	12 3/4"W x 42"H
REF2496	24 3/4"W x 96"H
REF3696	36"W x 96"H
PNL3696	36"W x 96"H
TK8	96"W x 4 1/2"H

**Includes:**

- One (1) decorative panel.

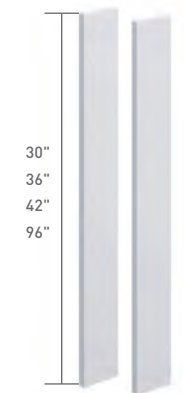

### 27. Filler

SKU	Dimensions
WF330	3"W x 30"H
WF336	3"W x 36"H
WF342	3"W x 42"H
TF396	3"W x 96"H
WF630	6"W x 30"H
WF636	6"W x 36"H
WF642	6"W x 42"H
TF696	6"W x 96"H

**Includes:**

- One (1) filler.
- One (1) Carcass panel in same size to easier installation.

## Cabinet Specifications

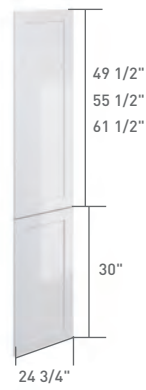

### 28. Shaker Style End Panel

SKU	Dimensions
MWEP1230	12"W x 30"H
MWEP1236	12"W x 36"H
MWEP1242	12"W x 42"H
MBEP2430	24 3/4"W x 30"H
MTEP2484	24 3/4"W x 79 1/2"H
MTEP2490	24 3/4"W x 85 1/2"H
MTEP2496	24 3/4"W x 91 1/2"H

Includes:  
- One (1) decorative panel.

### 29-1. Exclusive for Shaker

SKU	Dimensions
CVCM	2 7/8"W x 2 7/8" H x 96"L
CM4	3 1/7"W x 3 1/7"H x 96"L
BM8	3/4"W x 4 1/2"H x 96"L
RISER	3"W x 4"H x 96"L
SM8	1/4"W x 3/4"H x 96"L
LM8	1 1/2"W x 2"H x 96"L
OCM8	1 1/4"W x 1 1/4"H x 96"L

Includes:  
One (1) piece of moulding

NOTE:  
- CVCM and CM4 should be used with RISER

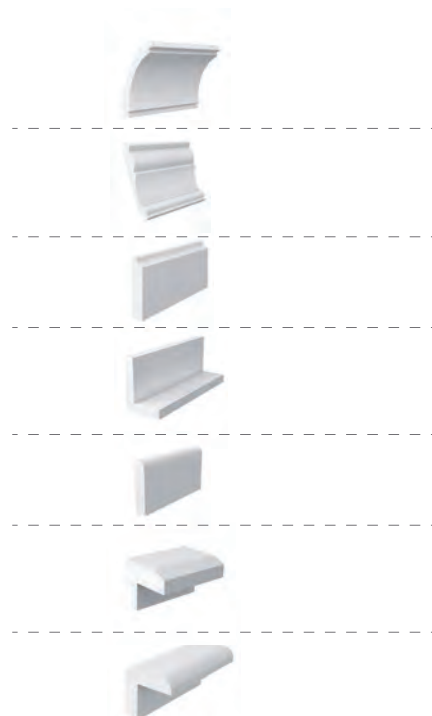

## Cabinet Specifications

### 29-2. Exclusive for Shaker

SKU	Dimensions
VAL36	36"W x 4 1/2"H x 3/4"D
VAL48	48"W x 4 1/2"H x 3/4"D

Includes:  
- One (1) curved valance



### 29-3. Exclusive for Shaker

SKU	Dimensions
COBEL-S	5 1/2"W x 10"H x 5 1/2"D











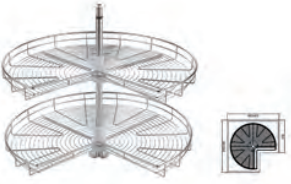

Includes:  
- One (1) corbel.





## Cabinet Specifications

### 30-1.Hardware

Overall Look	SKU	Overall Look	SKU
	ROT18 ----- ROT24 ----- ROT30		HW-DRAWER-LOW
	HW-BLS33 TRAY ----- HW-BLS36 TRAY  <b>NOTE:</b> - Applied with BLS cabinets		HW-HINGE45  <b>NOTE:</b> - Applied with WDC cabinets
	HW-BSR09-SPICE RACK ----- HW-BSR12-SPICE RACK  <b>NOTE:</b> - Applied with BSR cabinets		HW-HINGE105  <b>NOTE:</b> - Six-way adjustable 105 degree opening soft close hinges
	HW-BTC18-TRASH CAN  <b>NOTE:</b> - Applied with BTC18 cabinets		HW-HINGE135  <b>NOTE:</b> - Applied with BLS33 & BLS36 cabinets
	A-TK10		HW-HINGE155  <b>NOTE:</b> - Applied with BLS33 & BLS36 cabinets
	B-TK10		
	HW-DRAWER-HIGH		BLUM STAY LIFT

## Cabinet Specifications

### 31.Glass Door



SKU	Dimensions
GL-WMD1230	12"W x 30"H
GL-WMD1530	15"W x 30"H
GL-WMD1236	12"W x 36"H
GL-WMD1536	15"W x 36"H

Includes:

- One (1) decorative door

### 32.Floating Shelf



SKU	Dimensions
FS24	24"W x 2"H x 12 3/4"D
FS30	30"W x 2"H x 12 3/4"D
FS36	36"W x 2"H x 12 3/4"D

Includes:

- One (1) floating shlef.
- Two (2) T-supporter.

# LIMITED WARRANTY POLICY

## 5 YEAR RESIDENTIAL / 1 YEAR COMMERCIAL

OPPEIN warrants that its Cabinets and Parts should be free of substantial defects in materials and quality for 5 years (2 year for painted doors) following the acquisition date for Residential Customers and a period of 1 year following the acquisition date for Commercial Customers. The warranty period begins on the Purchase Date. This Limited Warranty applies to Domestic use only and covers defects in materials and quality. Labor and shipping are not included. Indoor Use Only. OPPEIN cabinetry warranty is not transferable to end-users, including consumers and homeowners who purchase OPPEIN cabinetry products through the original purchaser. All warranty actions are through the original Dealer where purchased. If that Dealer is no longer in business with OPPEIN, another dealer will be assigned.

In the event of an issue, OPPEIN will examine the product and, at its sole discretion, determine if the warranty applies. If the product is no longer available, OPPEIN will substitute a similar product. Color match is not guaranteed, as all cabinets will change over time. Please follow all assembly, installation, and care Instructions. This warranty does not cover normal wear and tear, water damage, outdoor use, or damage from misuse or abuse. The original Proof of purchase receipt is required. Please get in touch with the original Dealer or our website, [www.oppeinhome.com](http://www.oppeinhome.com) for more information.

By purchasing the product, the original purchaser acknowledges that natural wood may vary in texture, color, and wood grain, and it may exhibit subtle changes as it ages. Sunlight, smoke, moisture, household cleaners, and other environmental conditions may cause the materials to vary from their original color to warp, split, or crack. These variations are considered natural and related to the environmental exposure of the product and are not covered under this warranty.